

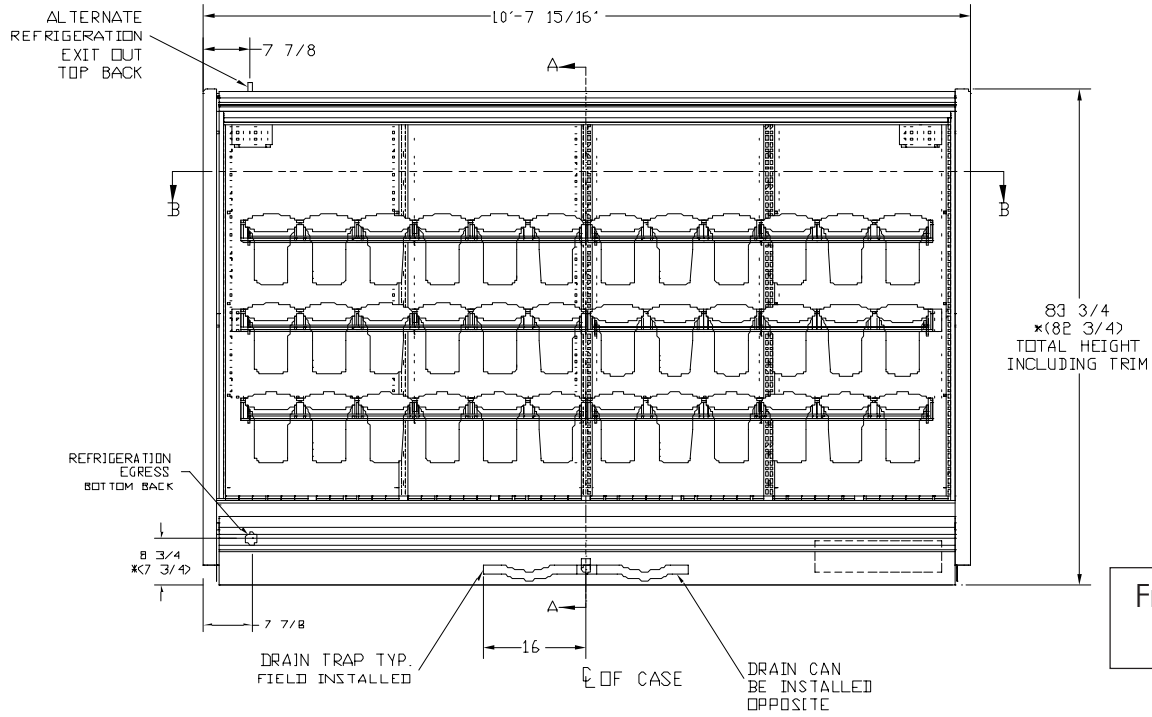

40MCCFL SPECIFICATION SHEET

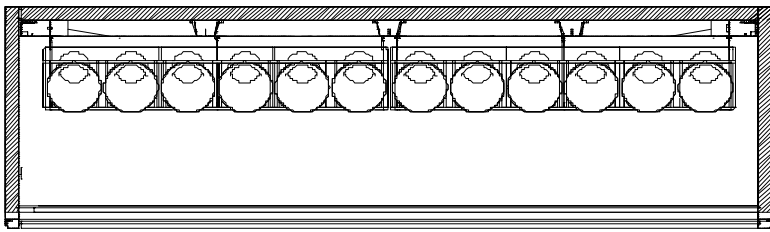

Front Elevation
40MCCFL



SECTION B-B

Top View
Shown in Section
40MCCFL

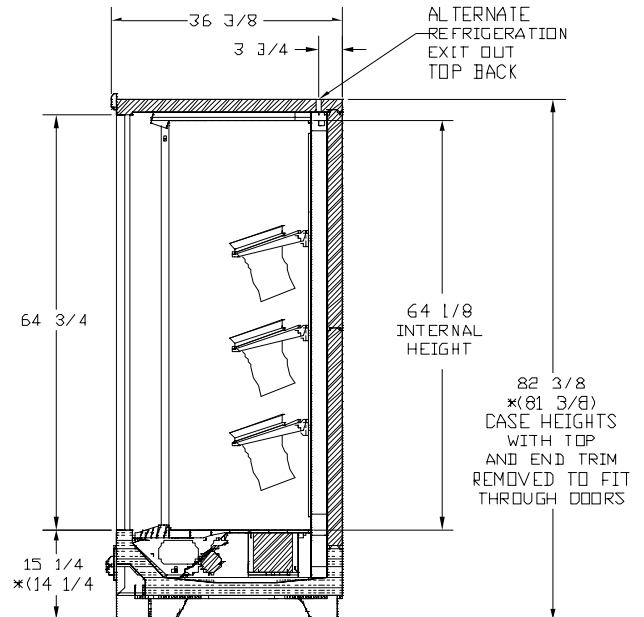

SECTION A-A

Side View

Zero Zone, Inc. • 110 N. Oakridge Dr.
North Prairie, WI 53153-9792
1-800-247-4496 • FAX: 1-262-392-6450
www.zero-zone.com



All specifications are subject to change without notice.